

Drill & Drop Installation Manual

Version: 6.0

Published: 2021

Drill!



Drop!



Done!



Please Read This Manual Before Installing the Drill & Drop Probe



- This manual was created to provide you with the knowledge to install the **Drill & Drop Probe** in a fast and correct manner.
- Reading this manual will assist you with the choice of the right tools and procedures. This should save you time and ensure a good installation quality of the probe.

List of Contents



Section	Page
Introduction to the Drill & Drop Probe	4
Safety Instructions	10
Installation Equipment Required	14
Recommended Installation - Heavy Soil Type Example	22
Augering Guidelines for the Drill & Drop Bluetooth Probe	39
Installation in Mounded Rows	47
Advanced Installations: Duplex Soils	56
Advanced Installations: Subsurface	61
Drill and Drop Probe Extraction Mk 1	81
Drill and Drop Probe Extraction Mk 2	93

Introduction to the Drill & Drop Probe



- Need for a rapid direct installation method.
- Uses a new fully sealed probe.
- Rugged construction.
- Uses a rigid tripod to maintain the augered hole integrity.
- Uses a tapered auger to suit the tapering of the probe.
- Ease of removal and reuse.

What is it?

OUR NEW INNOVATION: The SENTEK Drill & Drop

The tapered **Drill & Drop** multi-sensor profiling probe measures:

- ▶ Soil Moisture
- ▶ Salinity
- ▶ Temperature

It is wider at the top than it is at the bottom to ensure an agronomically correct slurry-free, snug fit and super-fast probe installation.

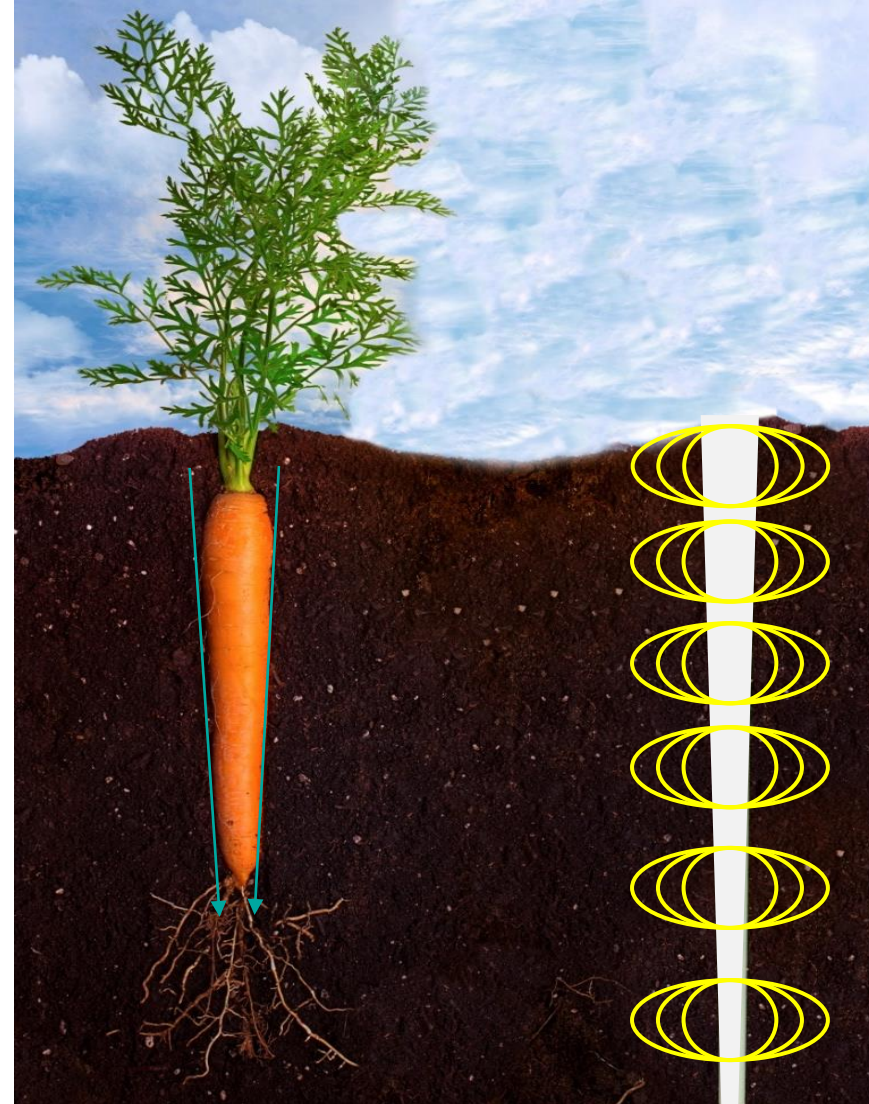

Why did we create it?

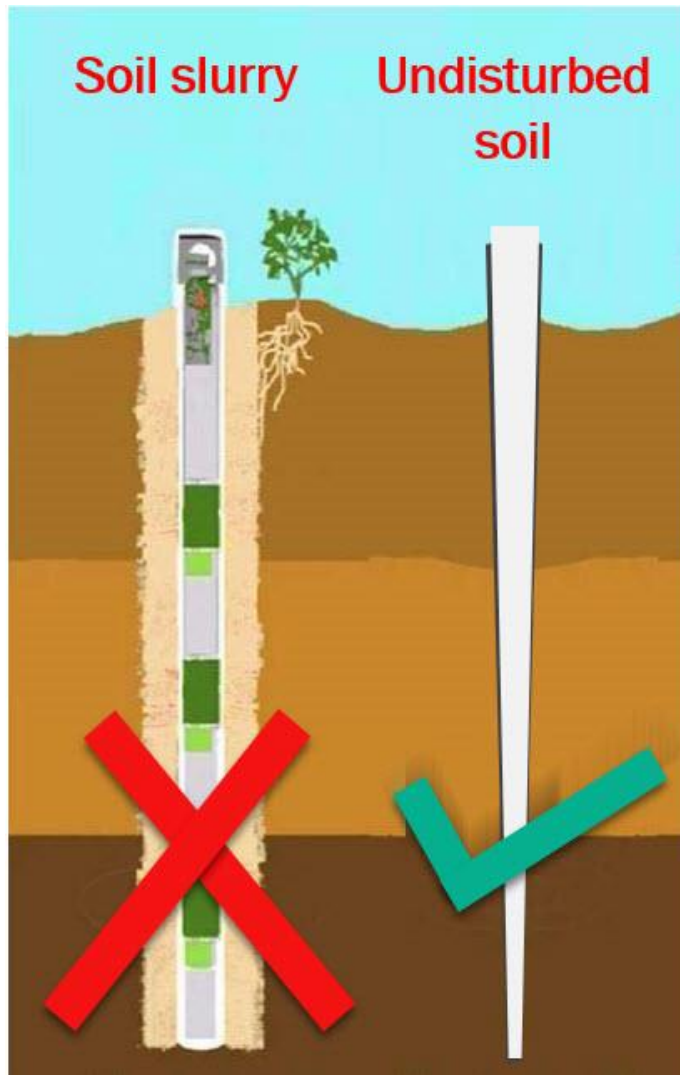

- Soil moisture probes are difficult and time-consuming to install – existing soil moisture probes require a lot of time and energy, especially when inserting down to 1.2 m (48”) ... until **NOW!!**
- The **Drill & Drop** measures an undisturbed soil medium, not a soil slurry that fills the air gap between soil and probe, which is being used by most soil moisture probe manufacturers.
- The slurry invites preferential path flow of water along the probe, providing misleading and potentially crop damaging information to the irrigator.

How does this solve the problem?



- Drilling tapered hole in soil.
- Dropping in a tapered probe.
- Done!



See "Sentek Videos"

Tapered Auger & Tapered Probe

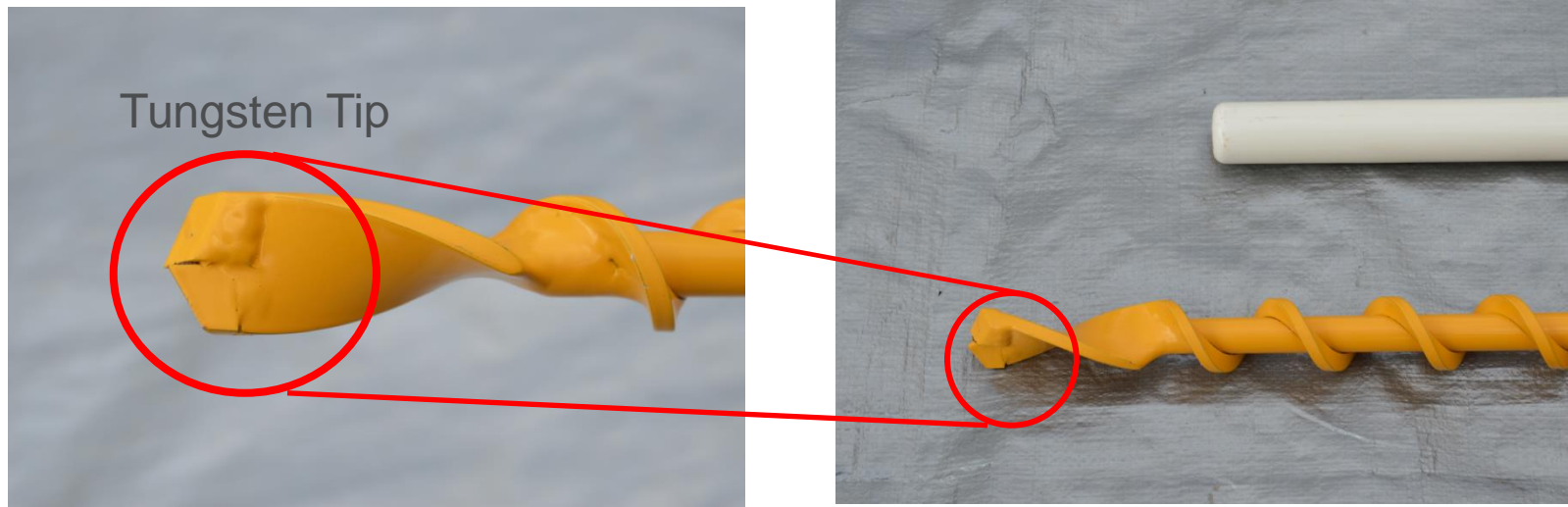

The **Tungsten-tipped** auger is a little longer than the probe. The tapered soil opening created by the auger is therefore deeper compared to the length of the probe body.

The resulting soil cavity below the bottom of the probe is designed to accept any soil accumulating at the bottom of the cavity during the installation process.

Otherwise, soil accumulation could obstruct the insertion of the probe body to its full length.

Quality of the Drilled Hole for Probe Insertion



It is not possible to achieve the quality and integrity of the drilled hole (as shown in the picture above) without using the Sentek Stabilisation Tripod for the tapered auger.

Warning: Not using the **Stabilisation Tripod** can lead to air gaps, potentially causing preferential path flow of water and misleading readings.

Safety Instructions



Warning!

- Read and follow all safety instructions in this Drill & Drop Installation Manual and the safety instructions in the **respective manuals of the recommended power tools** referred to in this manual.

Safety Precautions and Working Techniques



- A power drill is a high-torque, petrol or electrically powered tool. Some special precautions must be observed to reduce the risk of personal injury.
- It is important that you understand and observe the following safety precautions and warnings. Read this installation manual and the respective manuals for the tools recommended in this manual. Careless or improper use of any power drill may cause serious or fatal injury.

Danger

Drilling into or contact with electrical wires may cause severe shock, burns or death. Obtain information about buried power cables before commencing work.

Warning

Striking a hard object in the soil with a turning auger and the resulting slowing or stoppage of the auger creates reactive forces. The transfer of reactive forces can cause the auger powerhead and handles to rotate suddenly in the opposite direction and can result in loss of control or cause the handle to hit the operator resulting in injury. Always use auxiliary handles supplied with the tool.

Warning

Minors should never be allowed to use a power drill. Bystanders, especially children and animals should not be allowed in the area where a power drill is being used. Never let the power drill run unattended.

Safety Precautions and Working Techniques



Warning

- Do not lend or rent your power drill without the respective owner manual and this installation manual. Be sure that anyone using your power drill understands the information contained in the relevant manuals.

Warning

- When using an electric power drill and a generator as a power source in the field, hold the power tool by insulated gripping surface when drilling where the auger may contact buried wiring. Contact with a “live” wire will make exposed metal parts of the tool “live” and shock the operator. Ensure that the cord does not get wrapped around the spinning auger.

Warning

- Always wear certified safety protection. Wear ear and eye protection when operating power drills.

Warning

- To reduce the risk of injury, the operator should wear proper protective apparel. Clothing must be snug-fitting, but allow complete freedom of movement. Avoid loose fitting jackets, flared or cuffed pants or anything that could be drawn into the boring tool. Wear overalls or long pants to protect your legs. Do not wear shorts. Use gloves when handling the power drill.

Warning

- Always use the side handle supplied with the tool. Keep a firm grip on the tool at all times. Do not attempt to operate this tool without holding it with both hands. Operating this tool with one hand will result in loss of control when striking hard pans or stones.

Safety Precautions and Working Techniques



Warning

To reduce the risk of falling as a result of the forces created by the power drill, good footing is most important. Wear sturdy shoes with non-slip soles. Steel-toed safety boots are recommended.

Warning

Power drill noise may damage your hearing. Wear sound barriers (ear plugs or ear muffs) to protect your hearing.

Warning

Do not expose an electric power drill to rain or wet conditions.

Warning

When operating an electrical power drill outdoors, use an extension cord suitable for outdoor use.

Please refer to respective detailed user manuals and their safety instructions for the recommended tools in this manual:

- Operation of a generator.
- Operation of an electrical power drill with an auger.
- Operation of a petrol powered drill with an auger.

Installation Equipment Required

The background features abstract, overlapping shapes in shades of blue and green on the right side, set against a white background. The shapes are rounded and organic in form, creating a modern, clean aesthetic.

1. Installation Tools for Light Soils

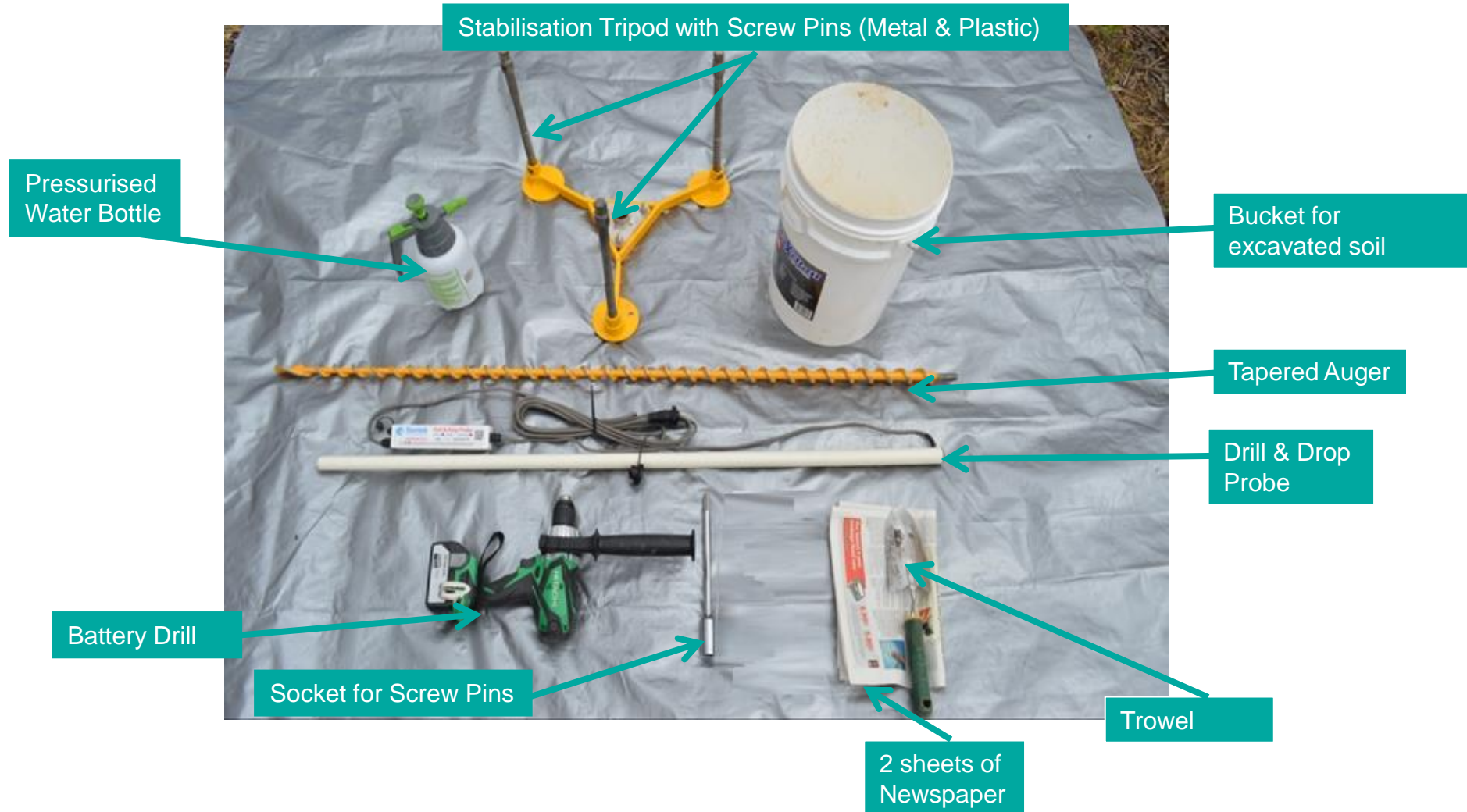

2. Installation Tools for Heavy Soils

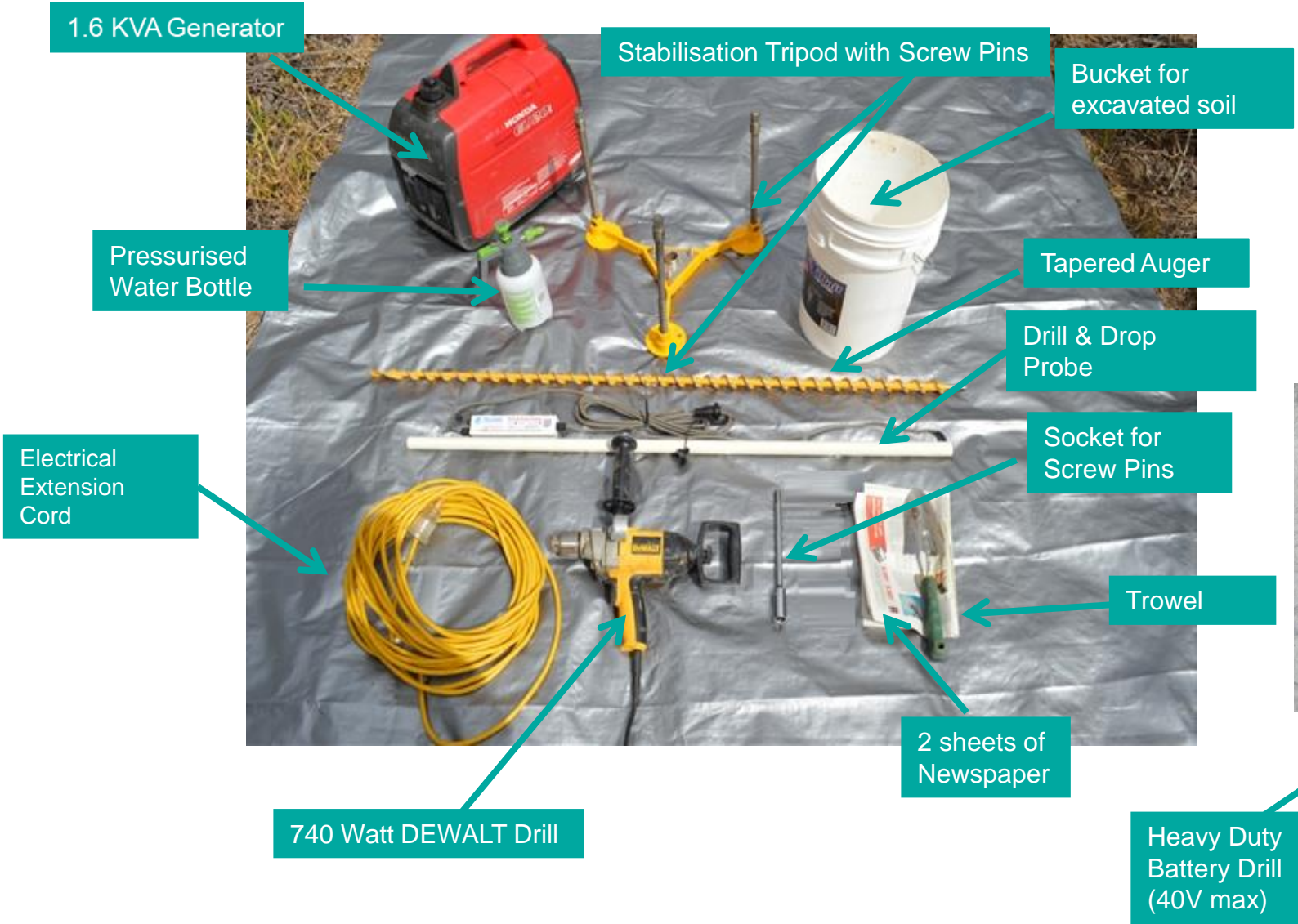

Heavy Duty Battery Drill (40V max)

3. Recommended Tools Important!



A Honda **EU20 i 1.6 KVA** Generator and a **740 Watt DEWALT** Drill have been intensively tested to drill holes in some very heavy textured soils.

These tools have not failed in the course of many installations and are **Highly Recommended**.

4. Recommended Tools Important!



Alternatively, a motorised power head may be used to drive the tapered auger. The one shown is an **ECHO EDR-2400** 2-stroke engine drill by **Yamabiko Corporation**.

5. Recommended Tools Important!



DISPLACEMENT	27.2 cc (1.6 cu. in.)
ENGINE POWER	0.8 kW (1.07 bhp)
WEIGHT	4.8 kg (10.5 lbs.)
FUEL TANK CAPACITY	250 cc (8.5 oz.)
DRILL SPEED	1st Gear: 910 rpm 2nd Gear: 2,710 rpm Reverse: 810 rpm
POWER SOURCE	Gas (Petrol/Oil Mixture)

This is an alternative drill power head from **Stihl**, which has also proven reliable.

6. Do Not Use a Battery-Operated Drill for Heavy Soils which is lower than 40v



7. Drill & Drop Tool Kit

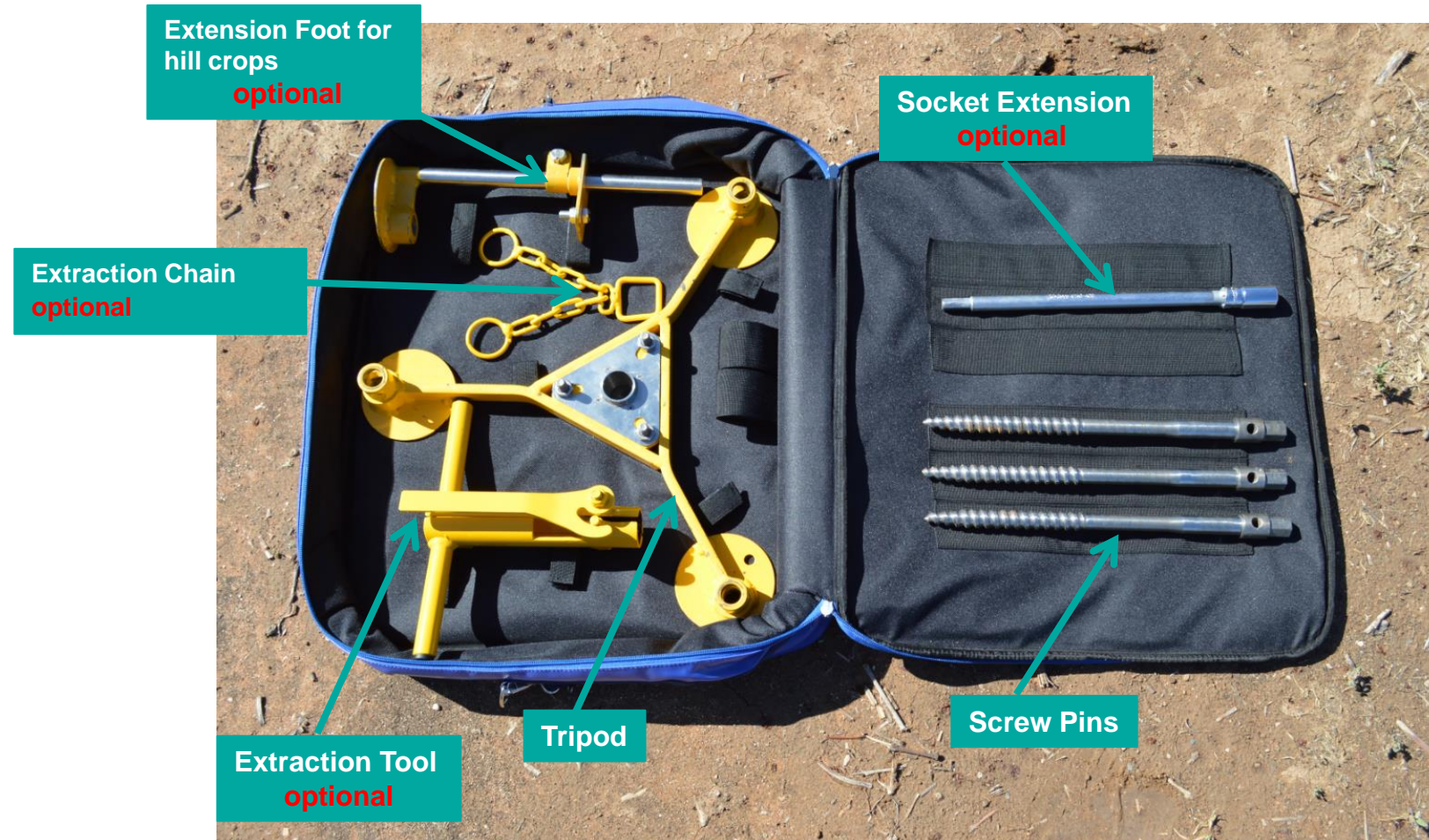

Recommended Installation

Heavy Soil Type Example

1. Tripod Installation



- Place 2 sheets of newspaper beneath the **Stabilisation Tripod**. This allows easy removal of the augered soil later.

2. Prepare Screw Pins for Drilling



- Insert the Screw Pins.

3. Place Socket into Drill



- Place the Socket Tool into the drill and tighten the drill chuck with the **chuck key**.

4. Drill Screw Pins into Soil



- Place one foot onto the centre of the tripod, position the **Socket Tool** onto the **Screw Pin** and keep drilling until the head end of the pin comes to rest on top of the tripod.
- Repeat with the remaining **2 Screw Pins** and then check the tripod stability manually.

5. Insert Tapered Auger into Drill



- Insert the Tapered Auger into the drill and tighten the drill chuck.

6. Augering

Insert the auger into the centre of the tripod keeping it as straight as possible. Start the drill and move the auger constantly and gently **10 – 15 cm** up and down during the drilling process.



This enables movement of the soil from the auger flight upwards and out of the drilled hole.

Note: The auger might be damaged if run in reverse!

7. Wetting the Auger



When the going gets tough in heavy soil, spray some water onto the auger and into the hole.

- In **clay**, this makes the drilling process easier by allowing the lubricated soil ribbons to travel up the auger flight and out of the hole.
- In **sand**, early use of water serves to maintain the integrity of the hole being augered and stops the hole wall collapse.

8. Augering to Depth



- Auger until the end of the auger flight is level with the top of the bush of the tripod and stop the drill. Then carefully remove the auger from the hole.

9. Test Depth of Hole Before Probe Insertion



- Reintroduce the auger carefully with the drill switched off.
- Push the auger until the top end of the flight is level with the hole of the tripod.

If the auger will not go down to this level, give the auger **a quick spin** to take up the soil at the bottom of the hole, then stop the drill, remove it from the hole carefully and clean it once again.

Important: Repeat the process until you can fully insert the auger without spinning into the hole. Only then is the hole **ready** to accept the probe.

10. Removal of Screw Pins



- Use the drill in reverse mode to unscrew the pins.

11. Inspect Quality of Hole



- Remove the tripod and inspect the quality of the hole. It should be smooth-sided and free of air pockets.
- Carefully remove the augered soil from the site using the newspaper.

12. Prepare a Probe Cable Trench



- Use a small trowel to dig a trench to accept the probe cable.
- During excavation, place your finger over the hole to prevent any soil falling in.

13. Preparation for Probe Insertion



- Use the spray bottle to wet the probe and the upper walls of the hole.
- This is particularly useful as lubrication in clay soils.

14. Probe Insertion



- Insert the probe carefully into the hole pushing it all the way down until the top of the probe is level with the soil surface.
- The first sensor will now be located at **5cm** depth.

15. Final Probe Positioning



- If the probe protrudes above the soil surface gently push it into final position. Do not use unreasonable force. (any weight beyond **120 kg** is considered to be unreasonable force).

16. Probe Installation Completed



The (almost) completed installation of the probe should look like this. The probe should be in firm contact with the soil and you should not be able to push it in any further by hand.

Note: The channel for the cable should be filled with soil.

Augering Guidelines for the Drill & Drop Bluetooth Probe



1.Explanation of Terms and measurements

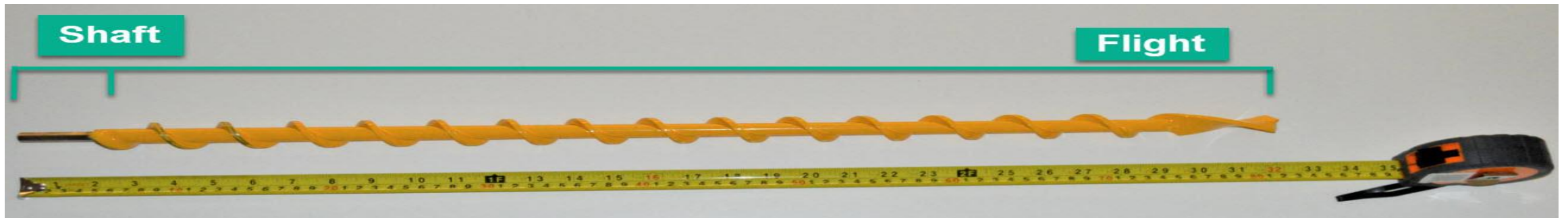

Probe Lengths in cm

Use recommended Auger Lengths in cm

Bluetooth probe		Auger		
Probe (excluding Bluetooth)	Bluetooth	Entire auger	Shaft	Flight
30	6	52	5	47
60	6	82	5	77
90	6	112	5	107
120	6	142	5	137

2. Poor Installs



Poor Install

- If the Aerial is not installed correctly it will lead to poor connectivity.
- Please make sure the **Blue Cap** must be fully exposed for better performance. (*if covered with soil/dry leaves etc the performance can be poor*)



Poor install

Top sensor in air and this affects the performance of the sensors buried below it.

3. Good Install



Good Install

- Aerial fully exposed above ground.
- All sensor buried in the soil.

4. Example : How to measure Height of Flight (not including shaft) above Tripod

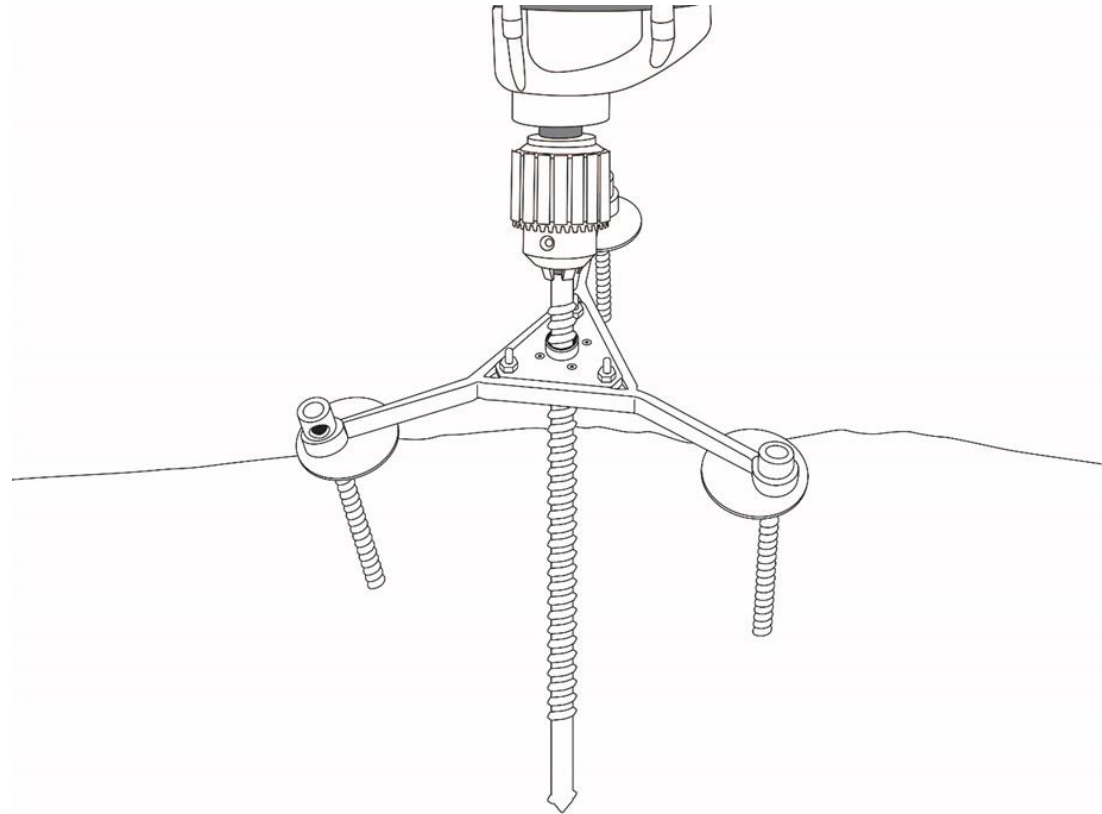
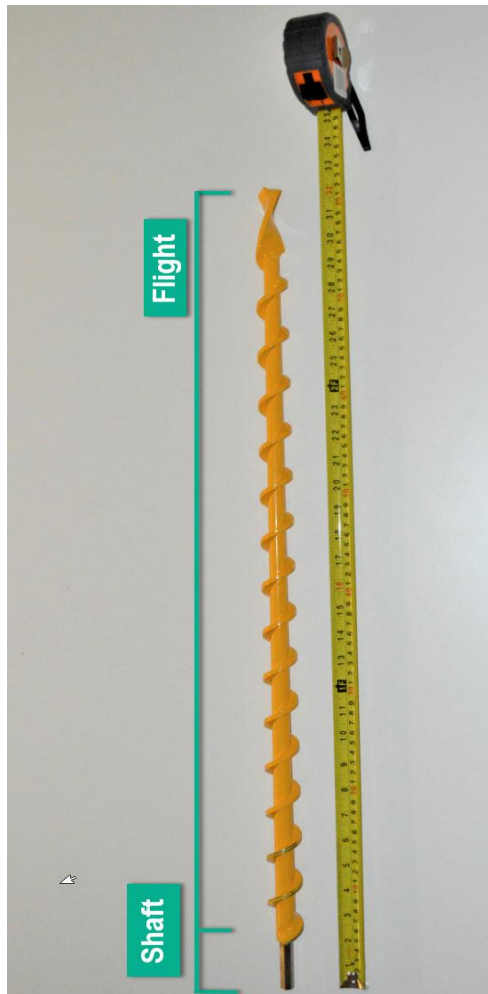

Graphic is not to scale and is for illustrative purposes only

5. Augering Guidelines for good Installs



Probe length	Soil	Height of flight above tripod top
30	sand	5 cm
60	sand	5 cm
90	sand	5 cm
120	sand	5 cm
30	clay loam	10 cm
60	clay loam	10 cm
90	clay loam	5 cm
120	clay loam	0 cm

In clay loam we advise you to check for correct depth by inserting the auger after cleaning the last load of spoil.

In dry sand we advise pre-wetting top soil by filling a tube (flower pot or bucket with base removed) inserted into the soil with water and leaving for at least 5 minutes. Then, whilst drilling, direct a constant spray of water at auger where it enters the tripod. When reaching the recommended depth, stop and switch off drill and carefully remove it from hole. Clean the last load of spoil and **do not** re- insert auger in the hole.

6. Post Insertion of Probe

- In clay loam or sand, finish inserting the probe to the correct depth as far as you can with your hand.



- Using the metal insertion tube, you can push down until the bottom of the probe cap is level with the soil surface.



7. Post Insertion of Probe

Note : We are not recommending using a plastic tube anymore, as it sometimes slips over the Bluetooth probe and gets stuck.



Installation in Mounded Rows

The background features abstract, overlapping shapes in shades of blue and green on the right side, set against a white background. The shapes include a large light blue area at the top right, a darker teal area below it, and a large green area at the bottom right.

1. Extension Foot for Tripod Stabilisation on Hills



- When installing the **Drill & Drop** probe in crops grown on hills an Extension Foot (circled) is used to stabilise the Tripod on the hill ridge.

2. Extension Foot Insertion



- Insert the Extension Foot into the Tripod Foot (green circled).
- Use the Tripod Foot with the pre-drilled hole (green circled).

3. Securing the Extension Foot



- Align the holes of the **Tripod Foot** and the Extension Foot, insert the **bolt** through the holes and tighten with the nut.

4. Extension Foot Height Adjustment



- Loosen the nut and bolt of the height clamp (circled) and slide the leg to the desired height.

5. Extension Foot Height Adjustment



- Re-tighten the nut and bolt (circled).

6. Tripod Levelling



- Use a levelling bubble to position the tripod correctly.

7. Pin Insertion into Tripod



- Insert the Tripod Screw Pins into the holes in the Tripod Feet and Extension Foot.
- Use an electric drill to secure the two Tripod Feet on the hill ridge and the Extension Foot in the furrow.

8. Completed Hill Tripod



- Two Tripod Feet are secured near the top of the hill, while the Extension Foot is secured at the bottom of the furrow.

Advanced Installations

Duplex Soils

1. Installation into Duplex Soils



Installation of the Drill & Drop probe into soils with a strong textural difference in the A and B horizons requires pre-drilling of the hole with a an undersized non-tapered auger first, followed by the tapered one.

In the example shown, this is done to prevent the deposition of lower layer clay shavings transported up the auger flight into the upper sandy layer (or vice-versa).

The sensor should only be measuring the sandy texture without any dispersed clay shavings within it.

2. Use a 24mm Non – Tapered Auger to Pre-Drill the Hole



Collar

Clay

Sand

Pre-level the tripod first.

3. Finish the Job With the Tapered Auger



Continue with Step 6 of the Augering Process



Advanced Installations

Subsurface

Subsurface Installations



- To hide the probe for aesthetic or protective purposes.
- To allow cultivation or harvest above the probe.
- To monitor lower soil depths.
- To insulate the probe from high surface temperature variations.

1. Drill & Drop Subsurface Installation Tools

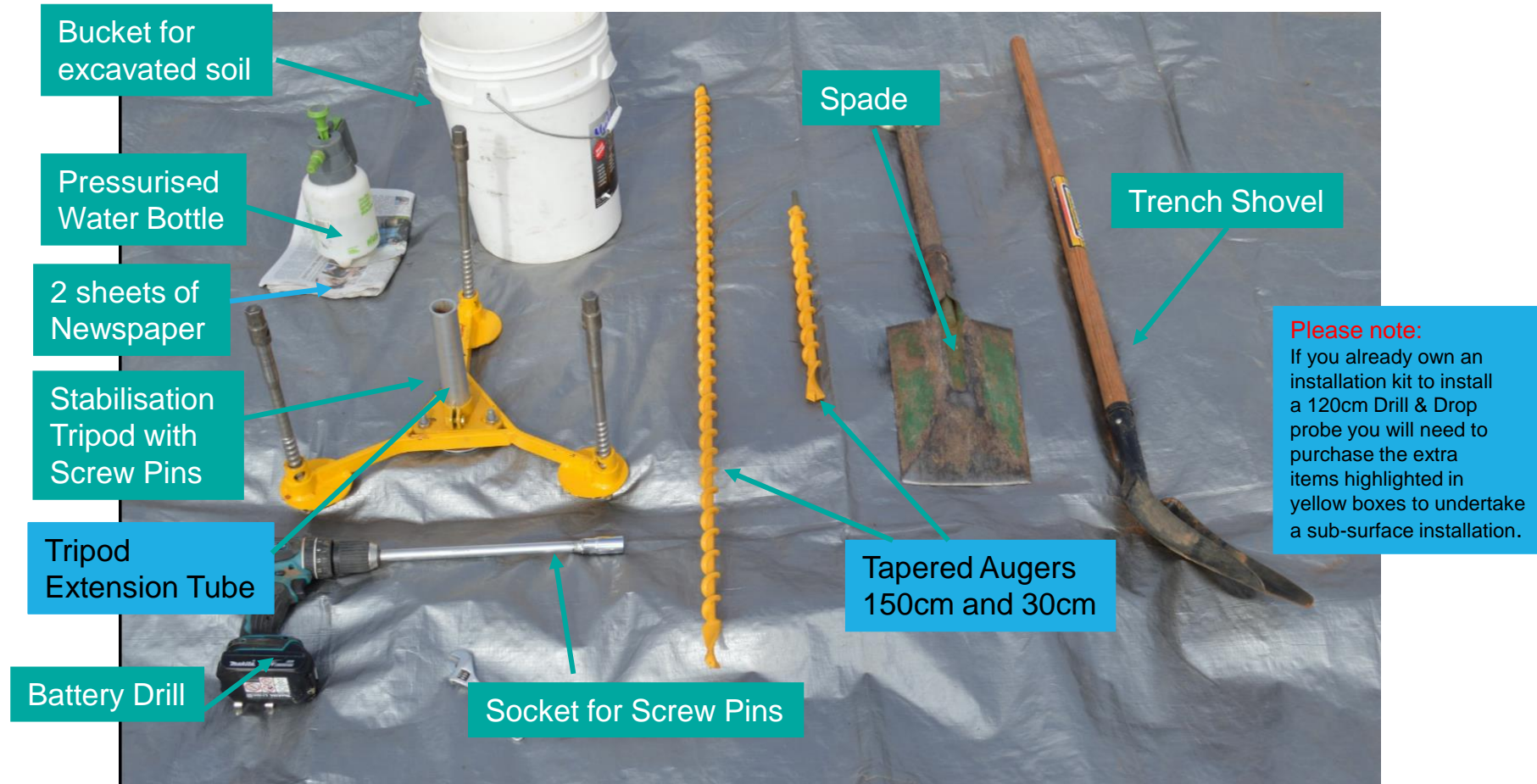

2.Tripod Extension Tube



The Tripod Extension Tube can be lowered into the soil opening for probe subsurface installation. This tube serves as both stabilisation and centralisation of the Drill & Drop auger.

3.Loosening the Extension Tube Nut



- Loosen the Extension Tube nut to release the Extension Tube.

4. Adjusting the Extension Tube Depth



- Adjust the Extension Tube to the desired depth of the probe below the surface (green arrow) and tighten the **Extension Tube** nut.

5. Excavation and Positioning



- Excavate the soil to the correct depth. Ensure that the bottom of the hole is level.

6. Positioning the Tripod



- Position the **Extension Tube** in the centre of the excavated hole and install the **Screw Pins**.

7. Augering the Soil

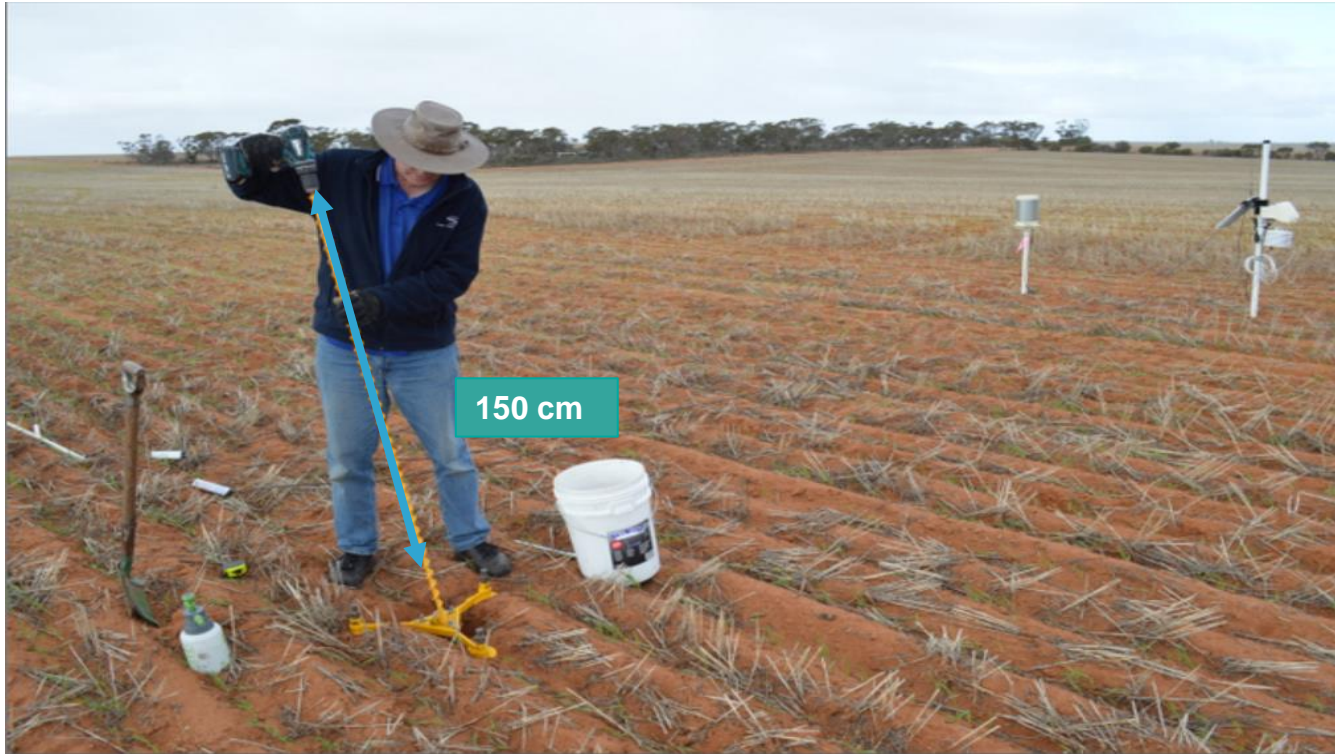

- Use the extended **150cm** subsurface auger.
- Measure and mark the auger at the required depth. Allow for the tripod centre height of **4cm**.

8. Augering the Soil



- Use a water spray bottle to lubricate and pick up the augered soil.
- Auger in short stages (30–50cm at a time), clearing the auger flights regularly.
- The excavated soil should be moist to maintain the integrity of the hole. Dry soil will collapse inward and lead to air gaps and failure of probe insertion.

9. Auger Insertion Test



- Drill to your auger mark, then carefully take the auger out, remove any soil from it and re-insert it back into the hole without rotating it.
- If you can insert it all the way then the hole is deep enough to receive the probe. If not then carefully auger more soil out and retest until sufficient depth is reached.

10. Removing the Tripod

- Before removing the tripod, remove any soil that may have landed in the hole around the **Extension Tube** .



- This will protect the augered probe hole during removal of the Tripod.

11. The Opening of the Soil for the Probe



- The augered hole should be circular with smooth sides visible near the top.

12. Excavation of Probe Cable Trench



- Place a finger carefully inside the augered hole to prevent soil entering and use a trowel to make a shallow 3cm deep trench to accommodate the probe cable.

13. Probe Insertion



- Spray water onto the **surface of the probe** and a little directly into the augered hole.
- Then immediately and smoothly insert the probe to maximum depth by hand.

14. Probe Insertion Complete



- If the insertion is incomplete, then apply smooth body pressure through your foot to insert the probe to full depth.
- In the above example, the probe top is located **20cm** below the soil surface.

15. Trenching the Probe Cable



- The entire cable is placed in a 20cm deep trench to protect it from cultivation tynes.

16. Installation of the 30cm Probe



- Use the 30cm **Installation Auger** and **Tripod**. As before, check the hole depth, make a **3cm** deep channel for the probe cable next to the probe, lubricate the probe with a little water and insert it.
- The cable may also be installed in a 20cm deep trench, but is more conveniently left on the surface so that the probe may be removed to one side temporarily at harvest and planting times.

17. Installation of the 30cm Probe



- The almost-completely installed **30cm** probe. The probe cable can be fitted with protective electrical cable conduit and buried adjacent to the probe.
- The cable can be left on the surface for convenient removal at times of farm machinery traffic.

16. EnviroSCAN MULTI with Split-System Sentek probes (5-25 & 25-135cm), rain gauge and ET₀ gauge

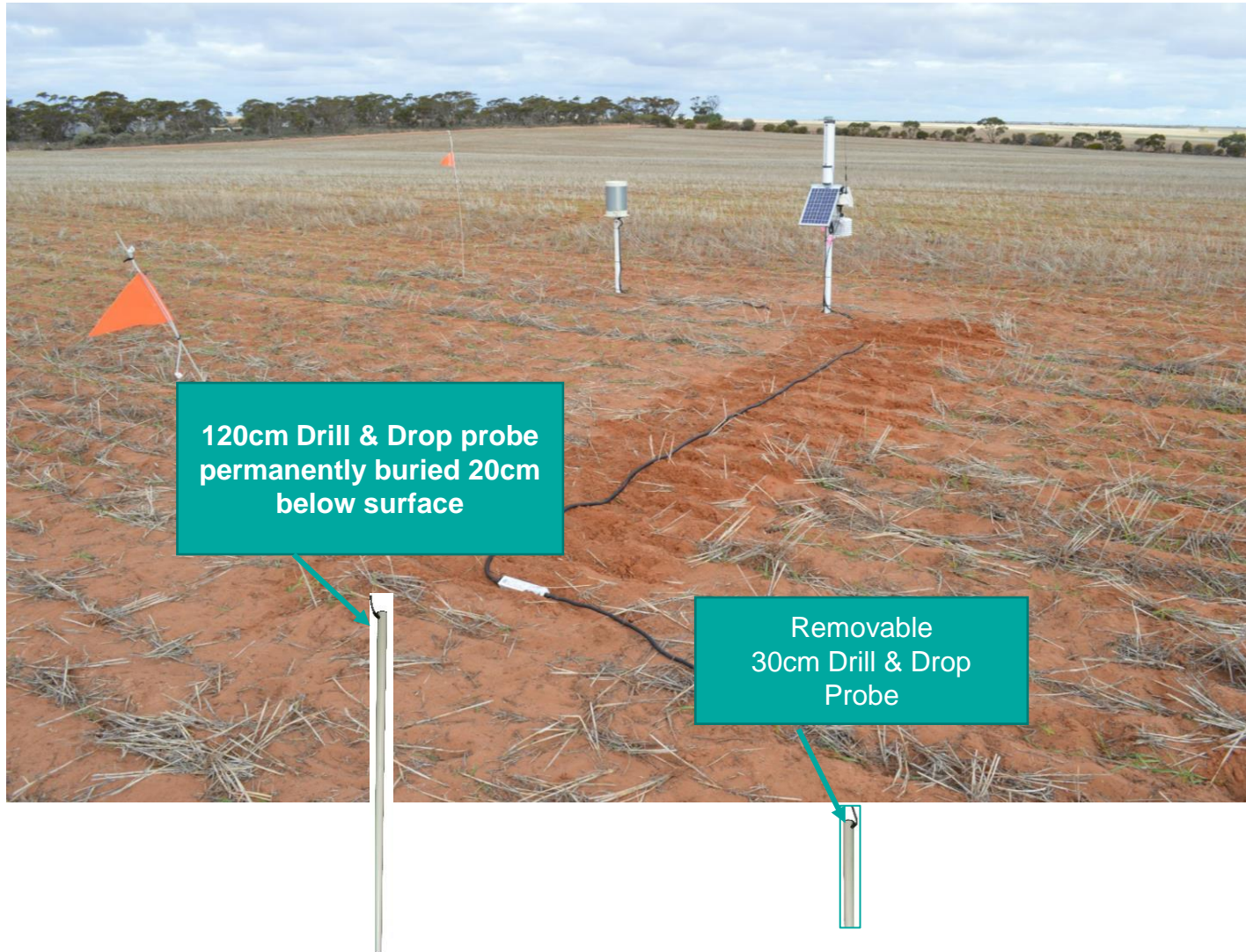

Drill & Drop Probe Extraction Mk1



1. Probe Extraction Tools



2. Excavate Soil Adjacent to Probe



- Excavate the soil adjacent to the probe to a depth of 20 cm.
- Wipe any soil or water from the probe using a piece of cloth.
- This will stop slippage of the Extraction Tool.

3. Fitting the Extraction Tool



- Fit the **Extraction Tool** around the excavated top of the probe with the probe cable located in the square opening of the extraction tool.
- Fold the cable down and line it up with the slit formed in the tool.

4. Fitting the Extraction Tool



- Fit the **Extraction Tool** around the probe so that it is at least 2 cm below the cable entry point.

5. Correct Positioning of the Probe Cable



In close-up: Locate the probe cable in the square opening of the extraction tool and hold it against the probe body below the tool lever as shown. Line the probe cable up with the split in the Extraction Tool.

This is done so that in the event of tool slippage, the cable will not be sheared off.

6. Tightening the Extraction Tool



- Move the lever of the tool from left to right as far as possible, being careful not to damage the probe cable.
- Grab the tool handle and pull with a **gentle** twisting motion to remove the probe.

7. Fitting the Chain



- If you cannot remove the probe by hand, fit the **Extraction Chain** onto the **Extraction Tool**, one circular ring for each handle and place wooden blocks next to the probe as shown.

8. Positioning the Crowbar and Blocks of Wood



- Locate the **square ring** on the crowbar and apply tension.

9. Breaking the Bond Between Probe and Soil



- Apply downward force to the crowbar until the probe lifts a little bit and the tight bond between probe and soil is broken.
- Adding a little water to the probe and allowing it to infiltrate will aid removal.

10. Probe Extraction



- Gently remove the Drill & Drop Probe when it becomes free of the soil.



11. Probe Extraction in Clays



- If it is not possible to remove the probe with a crowbar and blocks of wood, a **High Rise Car Jack** may be used.

Drill & Drop Probe Extraction Mk2



1. Probe Extraction

Note: For Bluetooth Drill & Drop Probe please skip Step 2.



- Dig out probe 15cm (6") as shown.
- Run the cable through the steel sleeve of the Extraction Tool as shown below.



2. Bluetooth Probe



For Bluetooth Probe, you can use the steel steeve of the Extraction Tool.

- Spray the small amount of lubricant ((RP7, WD40 or equiv) and place the steel steeve over the Drill.

2. Use of lubricant for sleeve extraction



- Spray a small amount of lubricant (RP7, WD40 or equiv) inside metal sleeve of Extraction tool.
- Place **metal sleeve** over Drill.

3. Extraction Tool

- Push insert into metal sleeve of the Extraction tool as shown below;



- Extract Drill & Drop Probe using a level based system as shown below or car jack.



4. Use of Rubber Mallet



- Use rubber mallet to remove Extraction Tool from **Drill & Drop Probe**.